



INGROUND LINER MEASURING FORM

TIPS FOR MAKING MEASURING YOUR POOL EASIER AND MOST ACCURATE!



Write clearly,
using black ink

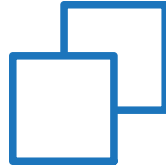

Keep a copy of the
measurements when
you're done



Measure in feet &
inches, rounding up
to the nearest
1/4 inch

- IF YOU HAVE A PREVIOUS POOL LAYOUT OR DIG SPEC: Ignore it. Actual measurements of the pool have to be made even if original pool plans are available due to the fact that variances often occur during construction.
- Supply all measurements in feet & inches, rounding measurements up to the nearest **1/4 inch**.
- Always measure from the floor to the bead receiver. Do not measure to the coping/top of the deck.
- Write legibly, using Black Ink only (No pencil or felt-tip marker). If we cannot read it or if your (6)s look like (0)s, costly errors can be made and liners are non-refundable.
- Make copies of everything! If we have questions regarding your measurement, you will need to be able to reference the material in question.
- Don't leave information out! It can delay your quote and order as well as affect the liner ordered.
- If you get stuck along the way, reach out to us at any time! We're here to help!

Your Name

Shipping Address

City, State, & Zip Code

Phone Number

Email Address

Today's Date

**After completion, submit this
form either by email or fax:**

EMAIL:

support@royalswimmingpools.com

FAX:

1-888-977-2846

Agreement between Royal Swimming Pools and the above named customer: Vinyl Liners are NOT refundable and cannot be returned. Customer assumes responsibility for ALL liner specifications.

Customer's Signature

Date

FILL IN THE BELOW STEPS ACCURATELY AND CLEARLY

STEP 1: NEW LINER PATTERN & THICKNESS

PATTERN:

MIL:

STEP 2: NEW LINER TYPE

- Stanadard Bead
- Low Hung Bead
- Overlap
- Other:

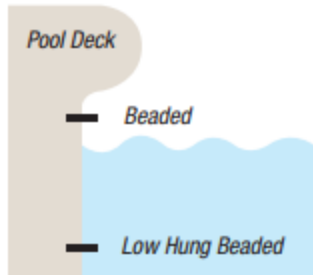

Extra Inches needed for Overlap

- Standard Bead
- Reverse Bead

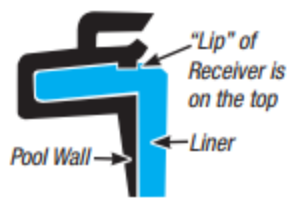
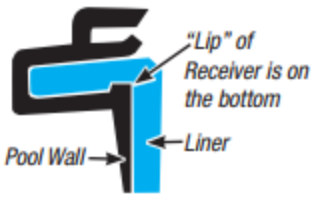

STEP 3: SELECT CORNER TYPES

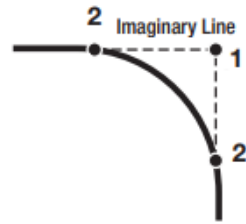

Radius Corners
Measurement from point 1 to point 2: Inches

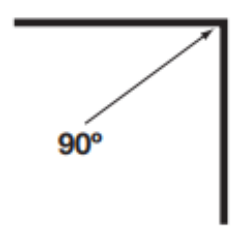

Square Corners
No measurements requires for square corners.

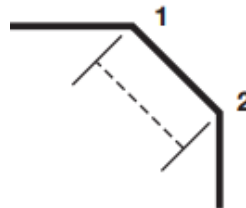

Cut Corners
Measurement from point 1 to point 2: Inches

Additional corner types are located on page 5
Fill in your type & it's measurements if your corners are different than above:

Step 3 assumes that all the corners in your pool are the same. If you have more than one type of corner on your pool - use this space to sketch the design of your pool. Indicate the corner type that differs and provide it's measurements.

STEP 4: INDICATE YOUR HOPPER TYPE (see measuring tip on page 5)

STANDARD HOPPER

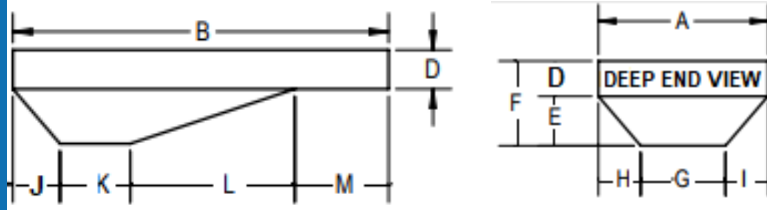

SPORTS BOTTOM

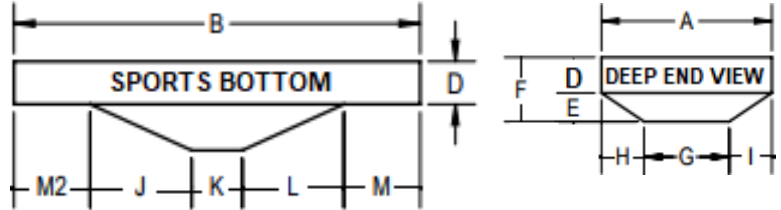

WEDGE BOTTOM

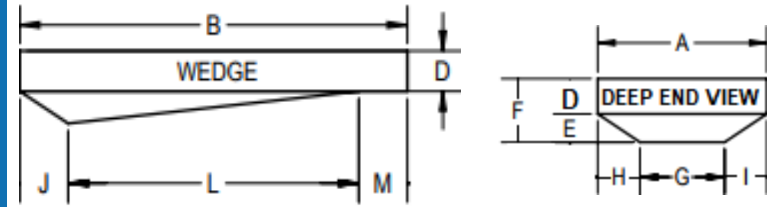

PLAY BOTTOM

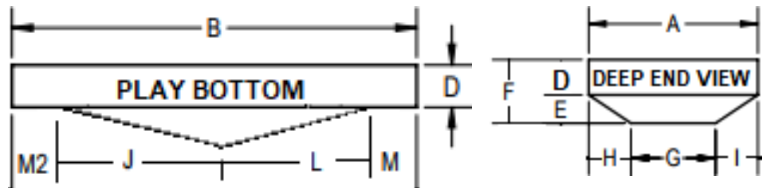

FLAT BOTTOM

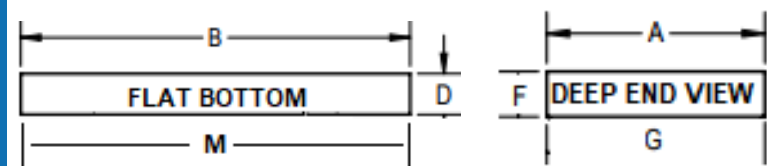

DEEPER FLAT BOTTOM WITH COVE

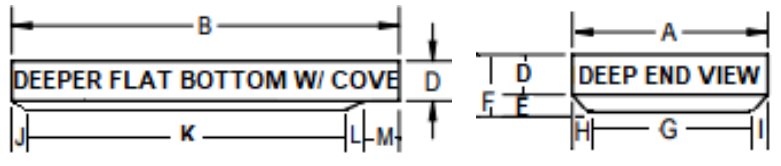

CONSTANT SLOPE

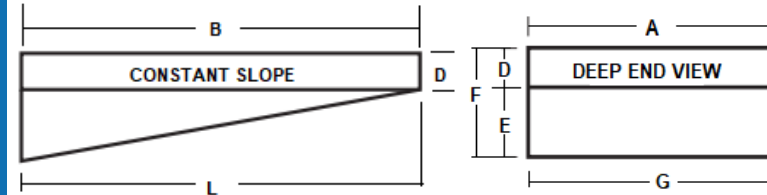

SAFETY LEDGE

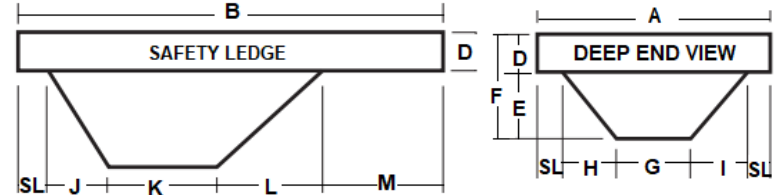

A= Feet Inches

B= Feet Inches

D= Feet Inches

E= Feet Inches

F= Feet Inches

G= Feet Inches

Safety Ledge (SL)= Inches

Bottom "bowled" (not flat)? YES/NO

If yes, supply drawing of bottom.

H= Feet Inches

I= Feet Inches

J= Feet Inches

K= Feet Inches

L= Feet Inches

M= Feet Inches

M2= Feet Inches

*Cove Offset= Inches

*Cove Depth= Inches

STEP 5: INDICATE YOUR HOPPER PAD TYPE

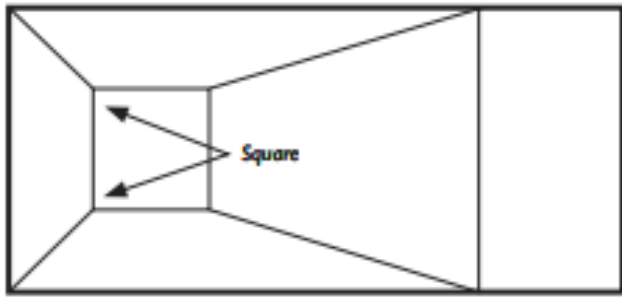

SQUARED HOPPER

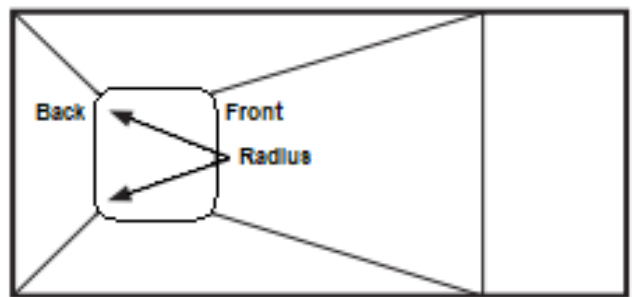

RADIUS (ROUNDED) HOPPER*

FRONT HOPPER RADIUS INCHES

BACK HOPPER RADIUS INCHES

*For tips on how to measure your pool's radius corners, see our blog [here!](#)

STEP 6: FINAL CHECKS

1. DO YOU HAVE VINYL OVER STEPS? YES NO

If Yes, please submit additional vinyl over step measurement form as well.

2. REQUIRED CHECKS

A is the total width of the pool and B is the total length from measurements taken in step 4.

- D + E must equal F (required for all rectangle pools)

The below measurements are required based on your HOPPER TYPE:

- J + K + L + M must equal B for Standard Hopper.
- J + K + L + M + SL must equal B for a Safety Ledge.
- H + G + I must equal A (without a safety ledge)
- SL + H + G + I + SL must equal A for Safety Ledge.

3. MEASURING THE SHALLOW END COVE:

(if applicable; not common)

The COVE OFFSET is how far the cove comes out into the pool.

The COVE DEPTH is the distance between the pool floor and the top of the cove where the cove meets the wall.

DO NOT measure on an angle! See tip on page 5.

Enter measurements on page 3.

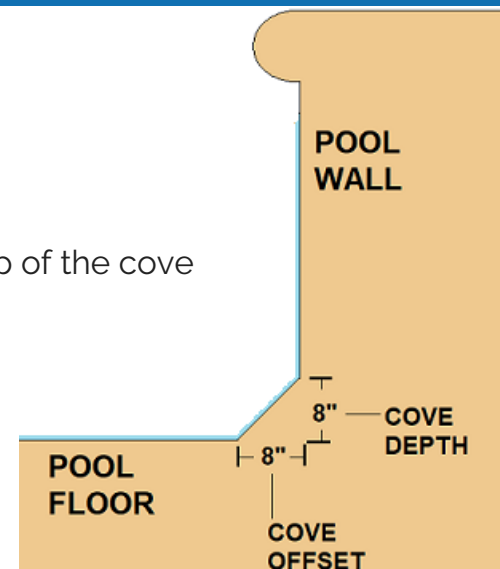

MEASURING TIP

BE SURE TO TAKE ALL MEASUREMENTS HORIZONTALLY!

If your quick checks above are off this may be why! See the image to the right for correct and incorrect measuring examples!

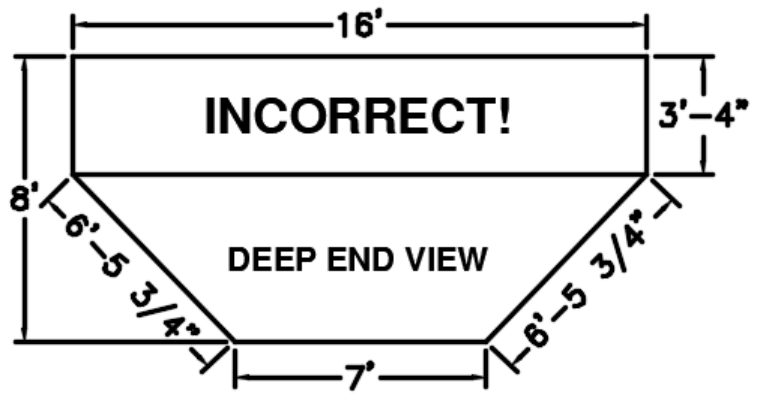
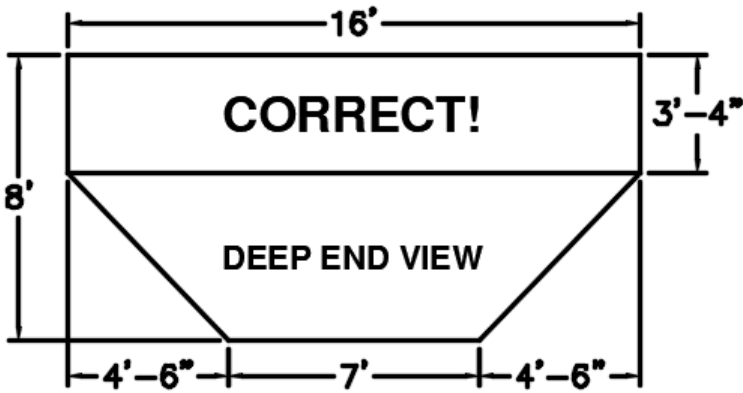

CORNER TYPE REFERENCES

<p>6" RADIUS</p>	<p>4' RADIUS</p>	<p>2'-6 9/16" RADIUS</p>	<p>25" RADIUS (DESJOYAUX)</p>
<p>1' RADIUS</p>	<p>50" RADIUS (DESJOYAUX)</p>	<p>6" CUT-OFF</p>	<p>2" CUT-OFF</p>
<p>2' RADIUS</p>	<p>2'-10" CUT-OFF</p>	<p>FOX CUT-OFF</p>	<p>OLD CASCADE / DAUPHIN 9" RADIUS @ TOP OF CORNER 3" RADIUS @ BASE OF CORNER</p> <p>POLYNESIAN SF-1 8" CUT-OFF @ TOP OF CORNER SQUARE @ BASE OF CORNER</p>